

B6 80W Series

Intelligent Balance Charger

All specifications and figures are subject to change without notice.
Printed in China © 2012



B6 80W Series

Intelligent Balance Charger

Instruction Manual

Warning:

- Do Using Input Voltage AC100~240V and DC 14V/16A simultaneously when charging or discharging
 - Do not charge for 2 or more groups of batteries simultaneously
- Both of these incorrect operating easily lead to short circuit of charger.

B6 80W Series Intelligent digital balance Charger Operating Manual

Special features.....	01
Performance parameter.....	02
Exterior and accessories.....	02
Key features.....	02
Operating instructions.....	03
Warning and error messages.....	11
Safety messages.....	12
After-sale service and guarantee.....	12

Special features:

- ▶ This charger employs an advanced charging calculation and design which allow multilayer error to be compatible. It can create a safe charging condition and maximum reduce the danger caused by negligence or setting error of user
 - ▶ This item adopt prevalent Synchronous buck & boost converter technology, this makes conversion efficiency up to 90%
 - ▶ Accept all types of R/C batteries: LiPo, Li-ion, LiFe, NiMH, NiCd, Pb
 - ▶ Simple and efficient user interface makes operation easy, with powerful function and abundant content. Real-time shows you the battery voltage、 charger current、 temperature of batteries、 capacity of charge/discharge、 elapsed time、 input voltage etc., therefore, you can inquire the present state and establish various safety-limited parameters conveniently.
 - ▶ This charger employs an individual-cell-voltage balancer to maintain you pack in balance while charging/discharging. During the process, it can monitor and balance each cell of the pack individually (Tolerance: +_0.01V)
 - ▶ Accept individual battery charging/discharging, so you can extend the scope of application of the charger. That is equally useful for the DIY battery.
 - ▶ Various of charging mode to meet different demand: charging-auto/balance charging/fast charging/storage and cyclic charging etc.
 - ▶ For users convenience it can store and load maximum five data of different batteries. You can establish the data contains program setting of the battery to charge or discharge continually. Three data can be called out at any time you need and the process can be executed without program setting.
 - ▶ Perform 1-5 cycles of charge>discharge or discharge>charge continually for NiMH/NiCd refreshing
 - ▶ You can connect a high-precision digital temperature sensor to protect the charger works in a safety temperature. Once a battery reaches the maximum temperature you set during charge/discharge, the process will be terminated to protect the battery. This is very important for NiMH/NiCd (separately purchased temperature sensor)
 - ▶ For technical expert, this charger offers PC based program can analysis the characteristic of the battery by USB port. It shows a graph of voltage, current, capacity and temperature curves and it also shows the individual voltage of each cell in the Lithium battery pack.
- *Separate purchased program kit(Ev-xxxA series)

- ▶ Do not attempt the voltage higher than the requirement by manufactures.
- ▶ Ensure the type of the battery and the voltage of the battery pack are selected correctly. Do not use the different types of different types or different capacities synchronously.
- ▶ The standard accessories can only support one battery pack. When you are willing to use multi-packs, please separately purchase the special accessories, never do a disassembly or alteration to the charger.
- ▶ Do not attempt to charge/discharge the non-recharged battery or damaged battery.
- ▶ Keep the charger away from children and pet at all time! Never leave the charger unsupervised when it is connected to its power supply.

After-sale service and guarantee

Thank you for purchasing this balance charger, we will do its best to provide you with a comprehensive after-sale service and protect your rights and interests. Since you purchase the unit, you can enjoy the lifelong guarantee service.

We warrant this product for a period of one year from the date of purchase, if it has a quality problem itself, all guarantee will be free; In case customers can not provide an effective certificate of purchase, we will refer the date of machine's internal.

If it is over one year since the purchase date, an appropriate cost will be charged, users need to bear the transportation cost back and forth.

User disassembly, alteration, or damage caused by improper use, they should bear the maintenance and transport costs.

After-sale procedure:

When you can not use the product normally, please contact the local franchiser or the after-sale service person. After products have been confirmed damaged or unable to confirm the causes, you can send it to the company directly or through the franchiser.

We will normally repair completed and send it to customers within five working days after receive it.

All rights revised by us to commit modifications.

BATTERY VOL TAGE
CELL LOWVOL



The voltage of one of the cell in the Lithium battery pack is too low. Please check the voltage of the cell one by one.

BATTERY VOL TAGE
CELL HIGHVOL



The voltage of one of the cell in the Lithium battery pack is too high. Please check the voltage of the cell one by one.

BATTERY VOL ERR
CELL CONNECT



There is bad connection at the individual connector. Please check the connector and cables carefully.

TEMP OVER ERR



The internal temperature of the unit goes too high. Cool down the unit.

CONTROL FAILURE



The processor can not continue to control the feeding current by any reason. The unit needs to be repaired.

Safety message

Although the charger is designed to work in a stable environment to play a role, but in use, you still need careful maintenance, as long as these important tips to follow, that is easy and effective use of your charger.

- ▶ When you start the process, especially the discharge process, the unit will become warm, please keep clear of the heat area and do not cover it by anything when using.
- ▶ Do not keep it in a environment below 5 °C or above 50 °C
- ▶ Use it carefully, do not use it in a wet or corrosive environment.
- ▶ Keep all the inflammable volatile materials well away from operating area.
- ▶ Please don't let the charger get hurt through falling, bumping, striking, shaking, and heavy press and so on.

Performance parameter

- | | |
|--------------------------------|--------------------------|
| ▶ Input voltage range | DC:11~18V
AC:100~240V |
| ▶ Charge current range | 0.1~6.0A |
| ▶ Discharge current range | 0.1~2.0A |
| ▶ Charge power limited | max.80W |
| ▶ Discharge power limited | max.10W |
| ▶ Balance current | max.300mA |
| ▶ Balance tolerance | ±0.01V |
| ▶ Nicd/NiMH battery cell count | 1~18cells |
| ▶ Lithium battery types | Li-po,Li-ion,Li-Fe |
| ▶ Lithium battery cell count | 1~6series |
| ▶ Pb battery voltage | 2-24V |

Exterior and accessories

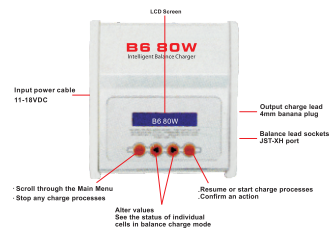

Key features:

- Mode Esc**: mode selection/stop/back button. Press this key to select in the main menu or back to the main menu and to stop during the process.
- Dec./Inc.**: reduce and increase button, you can browse other concerning information by this button during the charge/discharge process. When you are setting parameters, press **Dec.** key for reduce, and **Inc.** key for increase.
- Enter start**: select/enter button, to start work by press it more than 2 seconds.

Operating instructions:

► Main menu

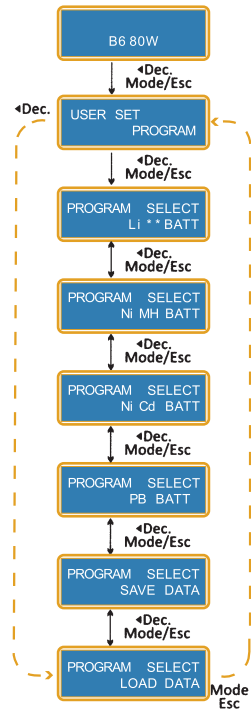

This shows you the type of charger for 2s, press **Enter start** into the main menu after self-check OK.

User set program, press **Mode Esc** key down and **Dec.** key upward for circulatory choose. Press **Enter start** key into submenu.

Lithium battery program

NiMH battery program

NiCd battery program

Pb battery program

Save data program

Load data program

Warning and error messages

- | | | |
|----------------------------|---|--|
| REVERSE POL ARI TV | → | The output is connected to a battery with incorrect polarity. |
| CONNECT ON BREAK | → | This will be displayed in case of detecting an interruption of the connection between battery and output or voluntarily disconnecting the charge lead during the operation of charge or discharge on output. |
| SHORT ERR | → | There was a short-circuit at output. Please check the charging leads. |
| INPUT VOL ERR | → | The voltage of input power drops below the limit. |
| VOL SELECT ERR | → | The voltage of Lithium battery pack was selected incorrectly. Verify the voltage of battery pack carefully. |
| BREAK DOWN | → | There happens the malfunction at the charger circuit by any reason. |
| BATTERY CHECK LOW VOLTAGE | → | The processor detects the voltage is lower than you set at Lithium program. Please check the cell count of the battery pack. |
| BATTERY CHECK HIGH VOLTAGE | → | The processor detects the voltage is higher than you set at Lithium program. Please check the cell count of the battery pack. |

▶ discharging Pb battery

Pb DISCHARGE
4.0A 12.0V(6P)

Mode/Esc
↕
Enter/Start >2s

Set discharge current on the left and final voltage on the right, the discharge current ranges from 0.1-5.0A and the voltage should be matched with battery being discharged. Start the discharge process by pressing **Enter/Start** key for more than 2 seconds.

Pb-6 0.4A 12.59V
DSC 022:43 00682

The screen displays the current state of discharge.

▶ save data and load data program

This charger can store /load up to 5 data of batteries, you can out the data for the process without setting up the program again.

▶ save data

PROGRAM SELECT
SAVE DATA

Enter/Start
↕
Mode/Esc

Press **Mode/Esc** key to the screen on the left, then press **Enter/Start** key to enter into the submenu.

SAVE (01) Ni MH
14.4V 3000mAh

Enter/Start >2s
↕
Mode/Esc

The blinking (01) shows you the data No, you can press **Dec./Inc.** key to change it. Press **Dec./Inc.** key can select the type of battery, voltage, capacity, and you can set them by pressing **Enter/Start** key, then press **Enter/Start** key for more than 2 seconds to select the charge mode.

Ni MH CHARGE AT*
CUR LIM T 5.0A

Setting up charge/discharge current and final voltage.

▶ load data

PROGRAM SELECT
LOAD DATA

Enter/Start
↔

LOAD (01) Ni MH
14.4V 3000mAh

Enter/Start >2s
↔

LOAD...

Press **Mode/Esc** key to the screen on the left, and then press **Enter/Start** key to enter the submenu.

You can press **Dec./Inc.** key to select the data number when the (01) field is blinking.

Press **Enter/Start** key for more than 2 seconds, it will show you the left screen, loading the data.

▶ Initial parameter set up

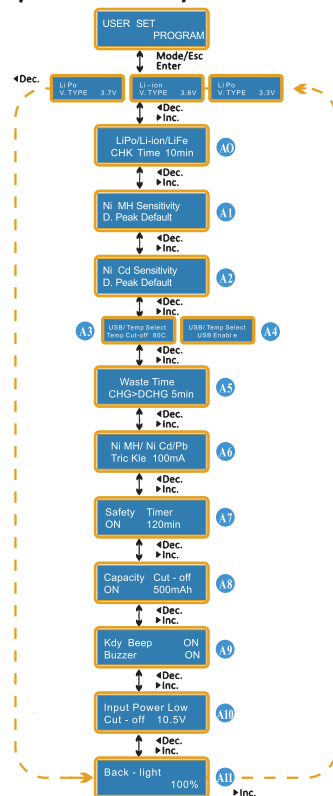

Tip: please set up correctly in the “user set” menu before into the job for the first time you use it.

Press **Enter/Start** key to the first screen on the left, then press **Mode/Esc** key to enter the into parameter setting menu.

You can switch at the same level menu by **Dec./Inc.** key. Please refer the detailed flow chart on the left.

When you are willing to alter the parameter value in the program, press **Enter/Start** key to make it blink, then change the value with **Dec./Inc.** key. The value will be stored by press **Enter/Start** key once.

This charger can accept three types of Lithium batteries: LiPo/LiIo/LiFe; you have to check the battery carefully and set it up correctly, or it will cause an explosion! (Please refer the table A)

This charge can recognize the cell count of Lithium battery automatically at the beginning of charge or discharge process to avoid from erroneous setting by user. But deeply discharged battery can be perceived incorrectly. To prevent the error, you can set the time term to verify the cell count by the processor. (See the screen A0)

Normally, 10minutes are enough to perceive it correctly. For the battery of larger capacity, you may reduce the term or use with the default value.

A1 A2 shows the trigger voltage for automatic charge termination of NiMH and NiCd battery(ΔV), the effective value ranges from 2 to 20mV per cell. If ΔV is set higher, there is a danger of overcharging the battery; if it is set lower, there is a possibility of premature of termination. Please refer technical specification of the battery. (NiCd: 12mV, NiMH: 7mV)

Tips: if the voltage of charging battery is lower than 2.5V, ΔV may not be perceived, this will cause a danger of discharge. You can connect a temperature sensor or use the charger current above 1C to avoid it.

There is a 3-pin port on the left side of the unit. It can be used as a temperature sensor port or USB port, if the port is assigned as a temp.port, you can use an optional temperature probe to contact the surface of battery (see the screen A3) and you can set the maximum temperature at which the danger should allow battery to reach during charge, once a battery reaches this value the process will be terminated to protect the battery. When it is selected as an USB port, you can connect the charger to your PC with an optional USB cable. This can utilize the optional software that can show you the charge process at PC. (See the screen A4)

When NiMH or Nicd battery is on the cyclic process of charge/discharge, it can often become warm. The program insert a time delay to occur after each charge and discharge process to allow the battery adequate time to cool down before being subjected to the next process. (See the screen A5) the value ranges from 1 to 60 minutes. If you are not sure, you can set it over 10minutes.

The charger will automatically supply the trickle function to achieve the full charge with out overheating the battery fast charge has been terminated. You can alter the trickle value when the charger shows you the screen A6

When you start a charger process, the integral safety timer automatically starts running at the same time. This is programmed to prevent overcharge the battery. If it proves to be faulty ,or if the temination circuit cannot detect the battery full. A7 shows you this program can be on or off, and you can set the maximum safety time, the value ranges from 10 to 720min.As the same principle, there is maximum-capacity-limited function. See A8 , the value ranges from 10 to 2000mAh.

At the screen A9 you can set the audible sounds to be on or off by this program.

When you use the car battery to supply power for charger, screen A10 shows you this program monitors the voltage of input DC battery. If the voltage drops below the value you set the operation forcibly terminated to protect the input attery. You can adjust the brightness of LCD screen at the charger (see A11)

Please refer the information below (chart A), and select the correct parameter for each battery, or it will cause a serious result!

Item	types	LI-Po	LI-Ion	LI-Fe	NIMH	NICD	Pb
Standard voltage (V/cell)		3.70	3.60	3.30	1.20	1.20	2.00
Max. Charge voltage cut off level (V/cell)		4.20	4.10	3.60	1.60	1.60	2.45
Allowable fast current		$\leq 1C$	$\leq 1C$	$\leq 4C$	$\leq 2C$	$\leq 2C$	$\leq 0.4C$
Min. Discharge voltage cut off level (V/cell)		≥ 3.00	≥ 3.00	≥ 2.00	≥ 1.00	≥ 0.85	≥ 1.75

► After check all the mode, to start the process press ^{Enter} ^{Start} key for more than 2 seconds.

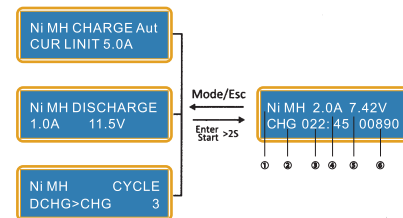

The screen displays the present state of process. To stop It press ^{Mode} ^{Esc} key;
Description: ①:the type of battery, ②:operating mode: CHG=charge\
DSC=discharge\
DCHG>CHG or CHG>DCHG=the cycle mode; ③:elapsed time,
④:charge/discharge current of the battery, ⑤:voltage of the battery pack,
⑥:capacity of charge/discharge

You can inquire the temperature and ΔV continually by press ^{Dec./Inc.} ^{Key}

► Pb battery program

This is programmed for charging Pb battery with nominal voltage from 2 to 24v, Pb battery can not be charged rapidly. They can only deliver relatively lower current compare to their capacity. The optimal charge current will be 1/10 of the capacity. Please always follow the instruction supplied by the manufacturer of battery.

► charging Pb battery

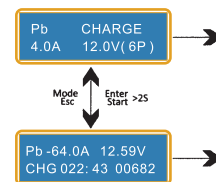

As you can see on left, you can set up the charge current on the left. The nominal of the second line and voltage of the battery on the right of the second line. The charge current ranges from 0.1-10.0A and the voltage should be matched with the battery being charged. Start the charge process by pressing ^{Enter} ^{Start} key for more than 2 seconds.

The screen displays the state of charging process. To stop charging forcibly, press ^{Mode} ^{Esc} key once.

▶ NiMH/NiCd battery program

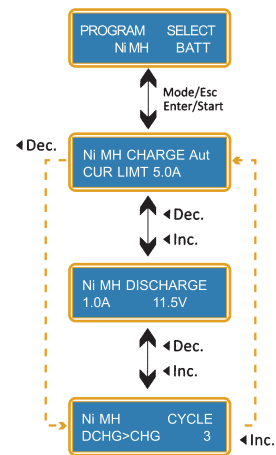

Press **Mode/Esc** key to the screen on the left, and then press **Enter/Start** key to **Enter/Start** into the submenu. You can switch at the same level menu to select the mode by **Dec./Inc.** Key. Please refer the detailed flow chart on the left. When you are willing to alter the parameter value in the program, press **Enter/Start** key to make it blink, then change the value with **Dec./Inc.** key. The value will be stored by pressing **Enter/Start** key once. Then press **Enter/Start** key for more than 2 seconds to start the process. Since the menu of NiMH is the same as NiCd, there is an example of NiMH only.

“CHARGE” mode the default mode is “AUT”. In “AUT” mode, you need to set the upper limit of charger current to avoid from higher feeding current that may damage the battery. Because some batteries of low impedance and small capacity can lead to the higher charge current by the processor at automatic charge mode. But in “Man” mode, it will charge the battery with the charge current you set at the display. Each mode can be switched by pressing start/enter key, when the current field is blinking, press **Dec./Inc.** key for more than 1 second.

“DISCHARGE” mode the discharge current ranges from 0.1A to 5.0A and the final voltage ranges from 0.1 to 5.0A and the final voltage ranges from 0.1 to 25.0V, the operating method similar as Lithium battery. The final voltage of NiMH battery is 1.0V/Cell, and the NiCd is 0.85V/cell, please refer the recommend by the battery of manufacturer.

“CYCLE” mode this charger can perform 1-5 cycles of DCHG>CHG or CHG>DCHG continually. You can select it for the new Ni** battery or the long-term placement Ni** battery. Please set up carefully or it will damage the battery! To set the parameter please follow the previous charge/discharge menu.

▶ Lithium batteries (Li-ion/LiPo/LiFe) program

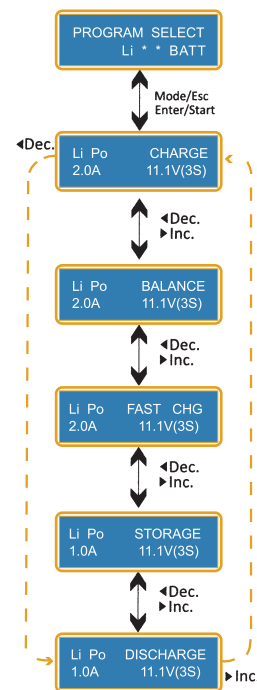

Press **Mode/Esc** key to the screen on the left, then press **Enter/Start** key to enter into the parameter setting menu. You can switch at the same level menu by **Dec./Inc.** key. Please refer the detailed flow chart on the left. When you are willing to alter the parameter value in the program, press **Enter/Start** key to make it blink, then change the value with **Dec./Inc.** Key. The value will be stored by pressing **Enter/Start** key once, and then press **Enter/Start** key for more than 2 seconds to start the process.

“AUTO charging” this is for individual Lithium battery or some special battery pack without balance port or cell count. The left side of the first line shows the type of battery you selected at the user setting. The right side of the first line shows you the mode of charge. The value on the left side of second line sets a charge current and the value on the right side of second line sets the cells count of the battery. The definition of the following screen is all the same. (To know how to connect, please refer picture B)

“Balance charging” this is for 2-6cells of Lithium battery with balance port, the battery pack being charged should have the individual cell connect, and connect it to the individual port at the right side of charger with a suitable connection cable that fits with your battery pack. (See picture B) In this mode, the charging process will be different from ordinary charging mode. The internal processor of the charger will monitor and control the voltage of each cell of the battery pack. This can improve the discharging performance of the battery! EV charger use the optimized calculation to control the tolerance in the range of $\pm 0.01V$!

“Fast charging” select this mode to finish charging process earlier. Principle: When the current down to 1/5 of the current you set during the CV term, it will stop the process and eliminate the forcible requirement of the balance precision. (Whether it is been connected to the balance port), the charging capacity may be a bit smaller than normal charging but the process time will be reduced.

“Storage mode” this is for charging or discharging Lithium battery not to be used for the time being. In order to reduce the wastage, you can select this mode to remain the power to 40% to store. The final voltage are different from the type of the battery, LiLo:3.75V- liPo:3.85V- LiFe:3.3V. This is an intellectual program, if the voltage of battery at its initial stage is over the voltage level to storage, the program will start to discharge, and if it is lower, the program will start to charge automatically. In order to ensure each battery pack meets the demand, the individual plug of the battery pack should be connected to the individual port of charger.

“Discharge mode” theoretically, Lithium battery do not need to discharge, especially deep-discharge. This feature is to ensure the power wastage of the Lithium battery over 90%, to avoid the overcharge of the individual battery, you should connect the balance plug of the battery to the charger, and the current may not exceed 1C.

► **Start to charge/discharge:** after set up the mode menu correctly, press ^{Enter}Start **Key for more than 2 seconds to start the process.**

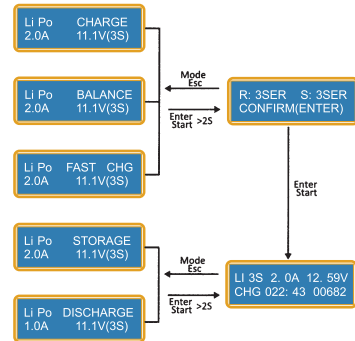

This screen shows the number of cells you set up and the processor detects. “R” shows the number of cells selected by you at the previous menu. If both numbers are identical you can start charging by press ^{Enter}Start button. If not, press ^{Mode Esc} button to go back to previous menu, and then carefully check the number of cells of the battery pack to charge again. If you selected the AUTO mode or discharge mode, you can pass over this screen directly.

This screen shows the present situation during charge process. To stop charging press ^{Mode Esc} key once; As you can see in the sketch on left, ①: for the cells count, ②: for the operating mode, CHG=charging at auto mode、BAL=balance charging mode、FAS=fast charging、STO=storage mode、Dsc=discharge mode; ③: elapsed time, ④: charge/discharge current, ⑤: charge/discharge voltage of battery, ⑥: capacity of charge/discharge.

► **According to press** ^{Dec./Inc.} **key you can inquire the individual voltage of each batteries and final voltage etc. continually as follow (this need to connect the balance plug):**

► Inc.
4.20 4.20 4.20
0.00 0.00 0.00

You can check the individual voltages of each cell in the battery pack while using the individual connection cable to the battery.

End Voltage
AUTOCHK

The final voltage will be reached at the end of process.

◀ Dec.
Capacity Cut - off
ON 5000mAh

You can inquire the safety capacity.

◀ Dec.
Safety timer
ON 120min

You can inquire the safety time.

◀ Dec.
USB/ Temp Select
Temp Cut - off 80C

You can use the 3-pin port as an USB port or inquire the safety temperature value.

◀ Dec.
EXT. Temp 0C

It show you the external temperature when the temperature sensor is connected you can inquire

◀ Dec.
I N Power VOLTAGE
12.60V

This shows the present voltage of input power